



**DANGER**

**Danger of electrical shock, burns or death.** Always remove all power sources before attempting any repair, service or diagnostic work. Power can be present from shore power, generator, inverter or battery. All power sources must be disabled and secured before performing any service.



**CAUTION**

If you lack the skills, tools or equipment to perform diagnostic or repair work leave such work to an authorized Winnebago Industries dealer or other qualified shop.

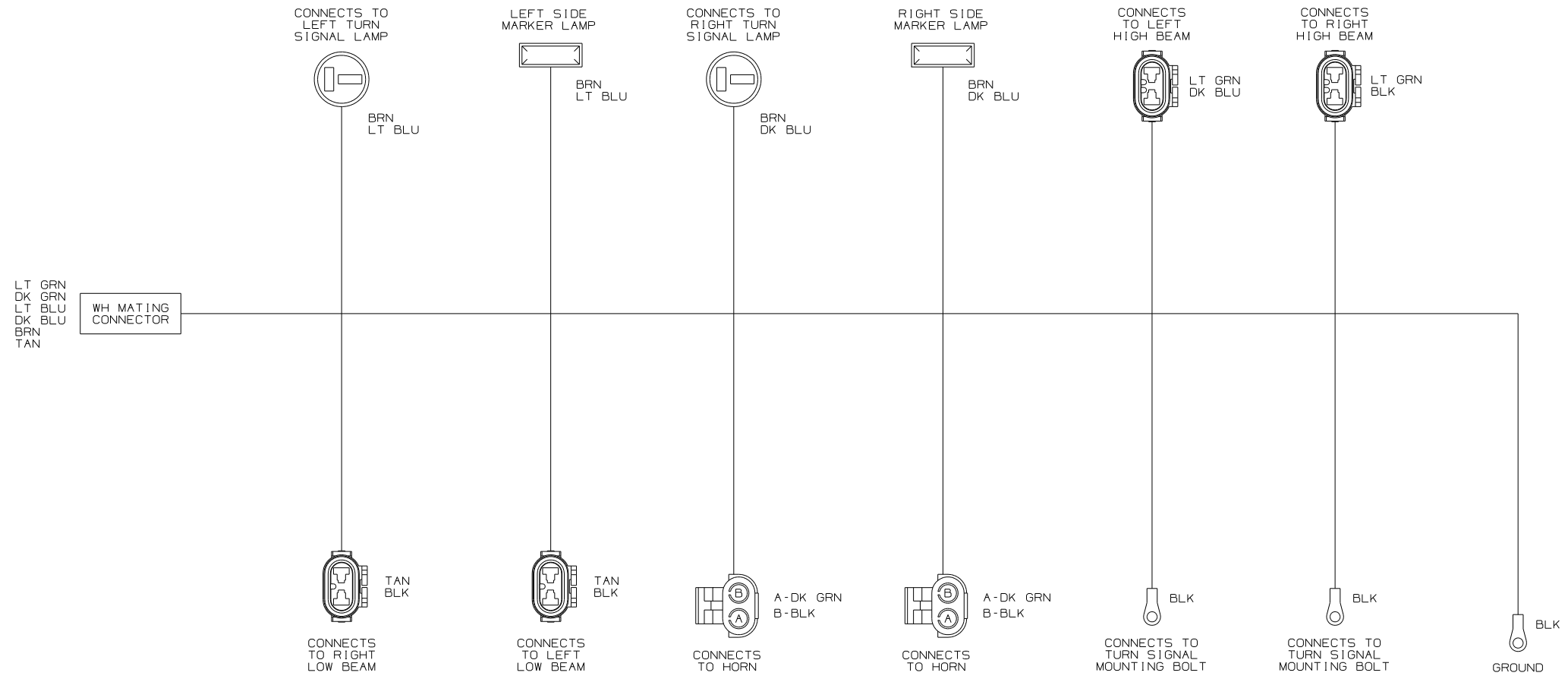

WIRING DIAGRAM-HEADLAMP, WH  
(WIRE ASM 148645-02 REV-E)

- 5 SEE WIRING DIAGRAM-AUTO FOR ADDITIONAL INFORMATION.
- 4 SEE MANUFACTURERS DIAGRAM FOR ADDITIONAL INFORMATION.
- 3 GROUNDS ARE SHOWN AS A SINGLE LINE FOR EASE IN TRACING. EACH GROUND CIRCUIT IS SEPERATE IN THE HARNESS.
- 2 NOT A SPLICE POINT. INDICATES ENTRY INTO WIRING HARNESS.

1. SPLICES ARE THEORETICAL AND MAY DIFFER IN THE HARNESS.

NOTES:

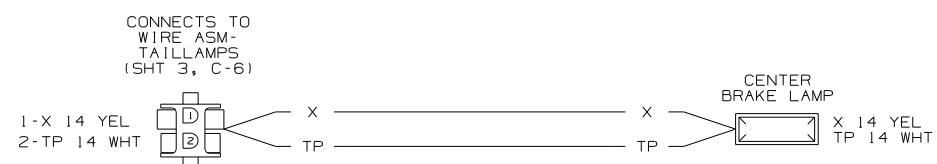

WIRING DIAGRAM-BACKWALL, BRAKE  
(WIRE ASM 132731-02 REV-D)

<b>WINNEBAGO</b>		COPYRIGHT 2004 WINNEBAGO INDUSTRIES, INC.	
DFTR	ORIG. DATE	ALL DIMENSIONS ARE IN MILLIMETERS	
CHKR		FIRST USED <b>05 D-SER</b>	
P.E.		UNSPECIFIED TOLERANCES ARE:	
M.E.		WHOLE DIM (X)	:
DSNR		ONE-PLACE (X.X)	:
		TWO-PLACE (X.XX)	:
		ANGLE	:
THIRD ANGLE PROJECTION		MATERIAL:	
DO NOT SCALE DRAWING			
TITLE: WIRING DIAGRAM-AUTO LAMPS			
SHEET 1 of 4	PART NO	148572	
REF:		1 7/30/2004	

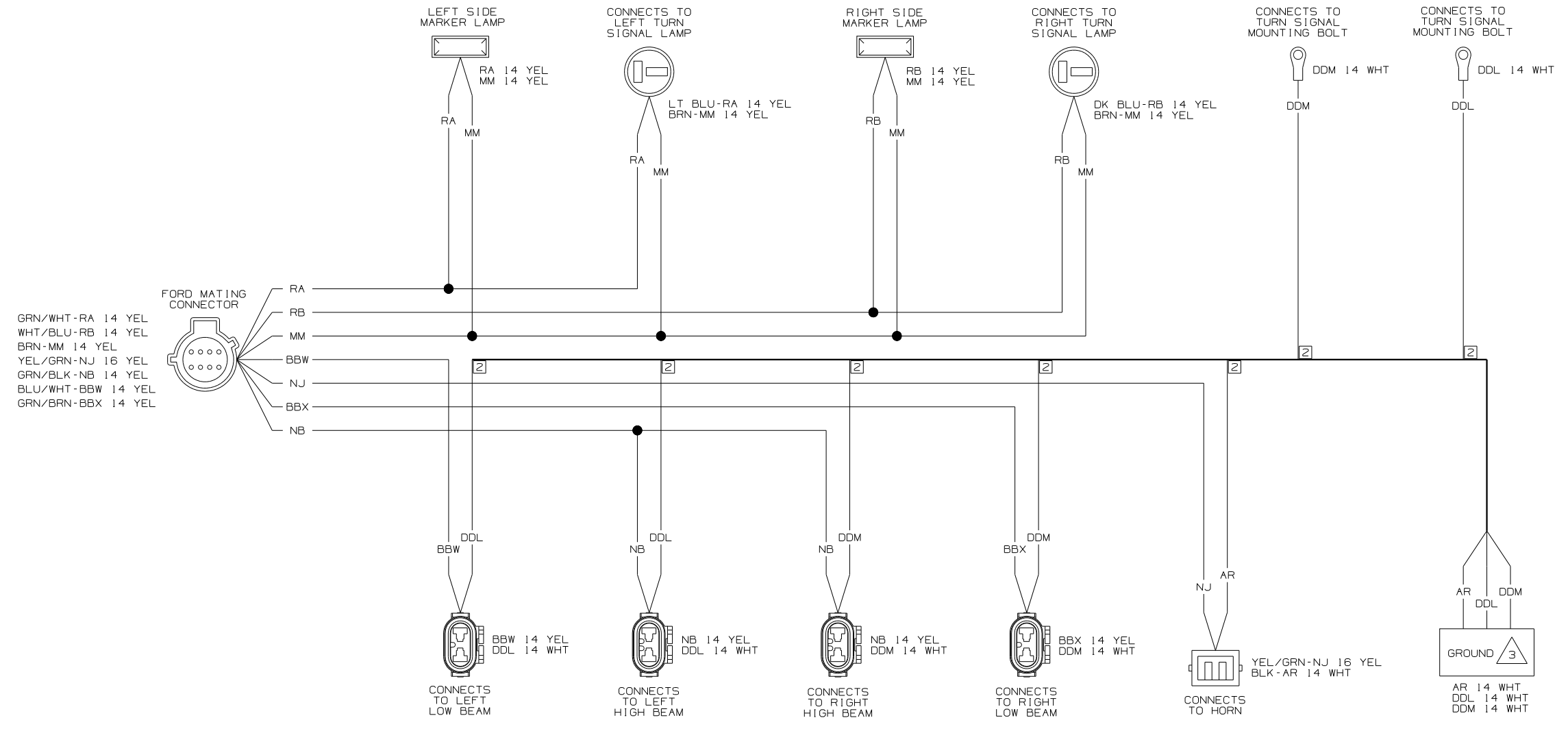

WIRING DIAGRAM-HEADLAMP,FD  
(WIRE ASM 148645-01 REV-E)

- 5 SEE WIRING DIAGRAM-AUTO FOR ADDITIONAL INFORMATION.
  - 4 SEE MANUFACTURERS DIAGRAM FOR ADDITIONAL INFORMATION.
  - 3 GROUNDS ARE SHOWN AS A SINGLE LINE FOR EASE IN TRACING. EACH GROUND CIRCUIT IS SEPERATE IN THE HARNESS.
  - 2 NOT A SPLICE POINT. INDICATES ENTRY INTO WIRING HARNESS.
1. SPLICES ARE THEORETICAL AND MAY DIFFER IN THE HARNESS.

NOTES:

FIRST USED	05 D-SER
TITLE	DO NOT SCALE DRAWING
WIRING DIAGRAM-AUTO LAMPS	
SHEET 2	PART NO 148572

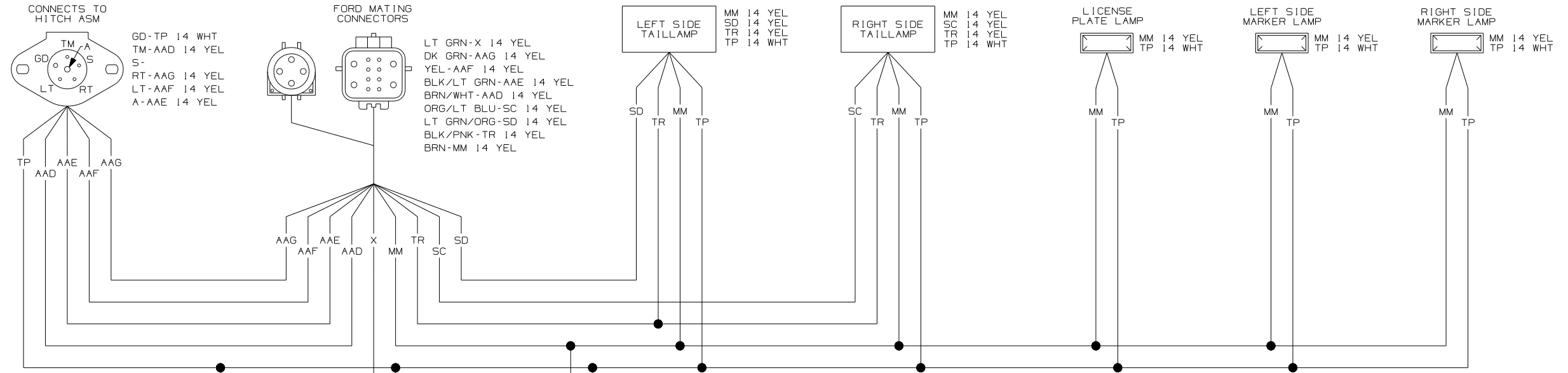

WIRING DIAGRAM-TAILLAMPS,FD  
(WIRE ASM 145777-01 REV-C)

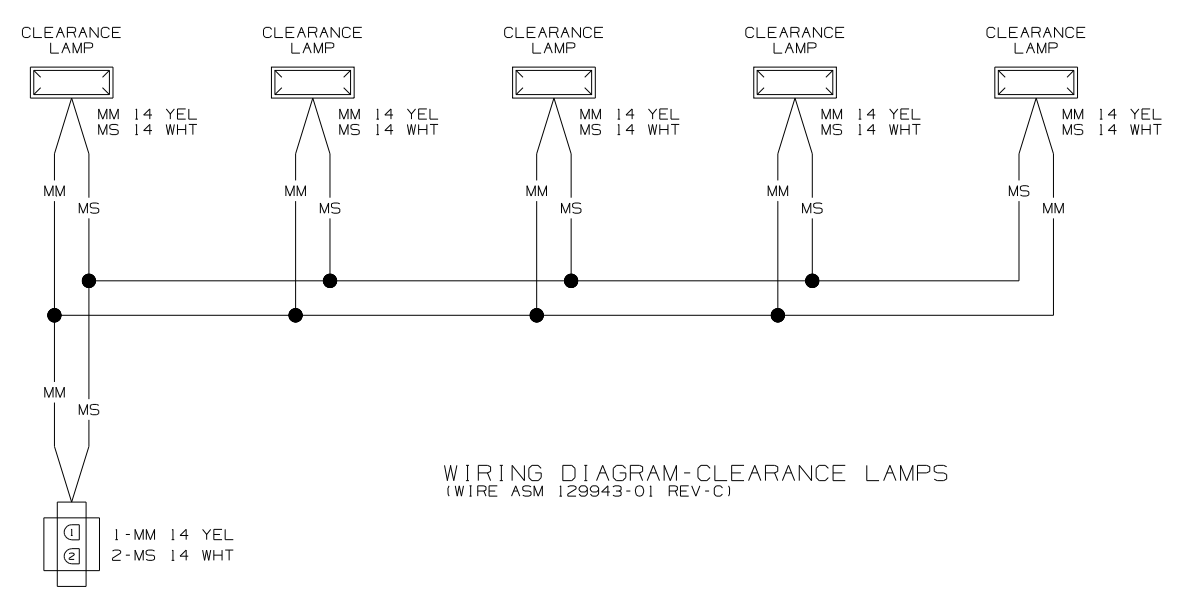
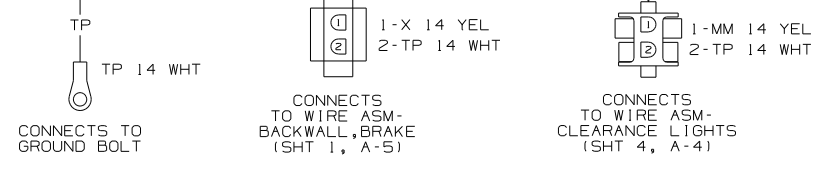

WIRING DIAGRAM-CLEARANCE LAMPS  
(WIRE ASM 129943-01 REV-C)

- 5 SEE WIRING DIAGRAM-AUTO FOR ADDITIONAL INFORMATION.
  - 4 SEE MANUFACTURERS DIAGRAM FOR ADDITIONAL INFORMATION.
  - 3 GROUNDS ARE SHOWN AS A SINGLE LINE FOR EASE IN TRACING. EACH GROUND CIRCUIT IS SEPERATE IN THE HARNESS.
  - 2 NOT A SPLICE POINT. INDICATES ENTRY INTO WIRING HARNESS.
1. SPLICES ARE THEORETICAL AND MAY DIFFER IN THE HARNESS.

NOTES:

FIRST USED	05 D-SER
TITLE	DO NOT SCALE DRAWING
TITLE	WIRING DIAGRAM-AUTO LAMPS
SHEET 3	PART NO 148572

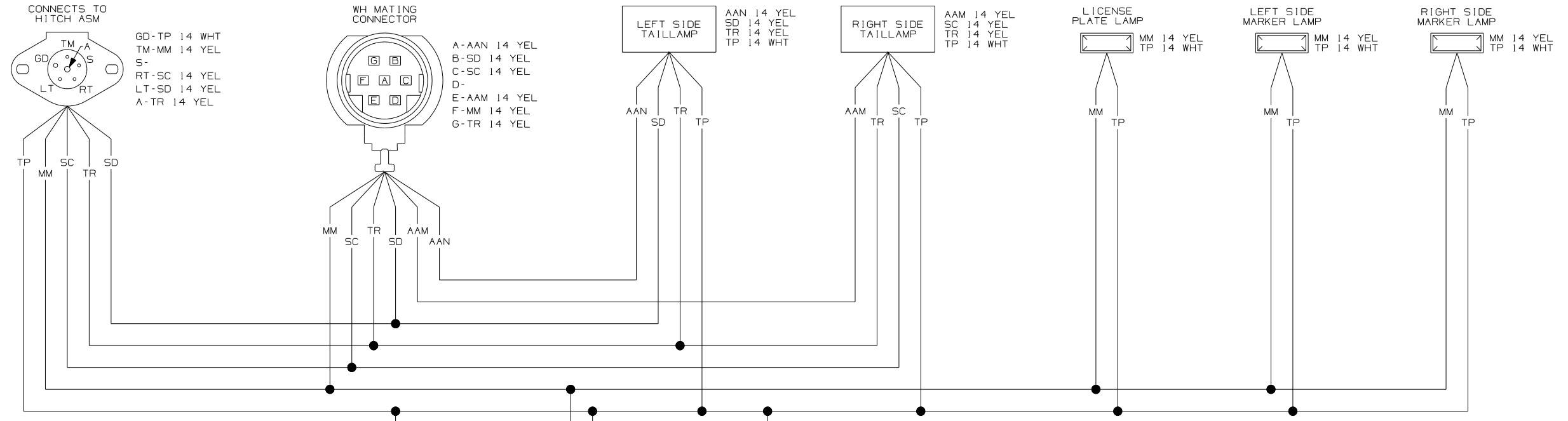

WIRING DIAGRAM-TAILLAMPS, WH  
 (WIRE ASM 145777-02 REV-C)

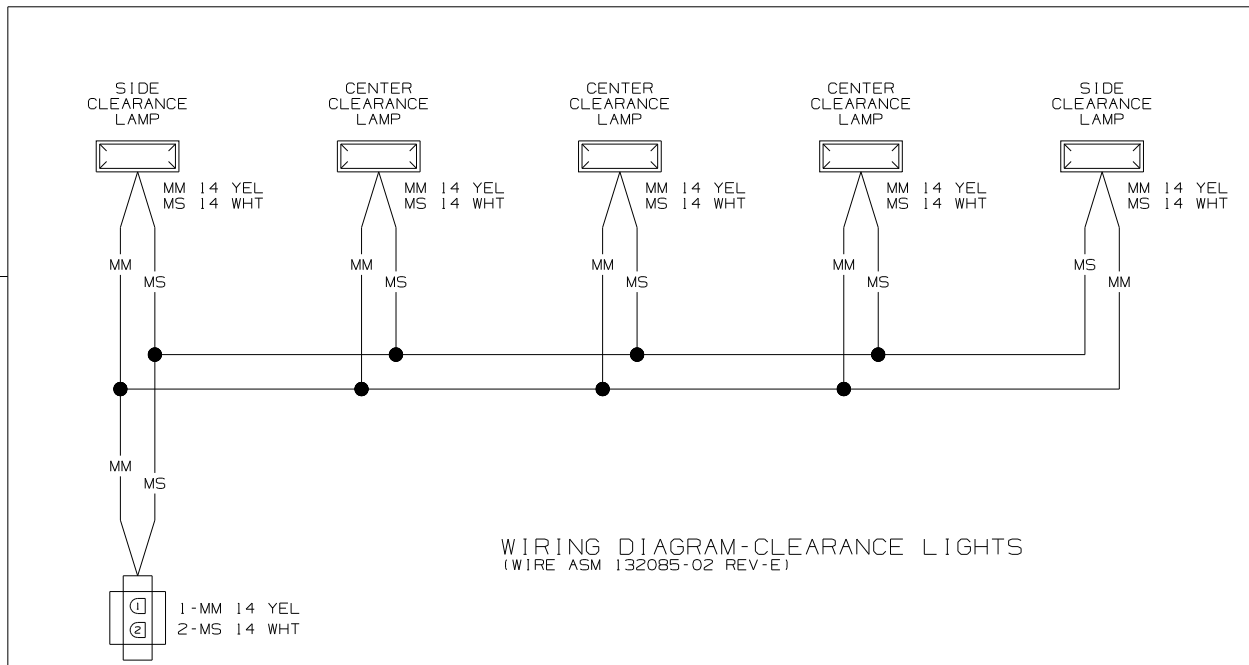
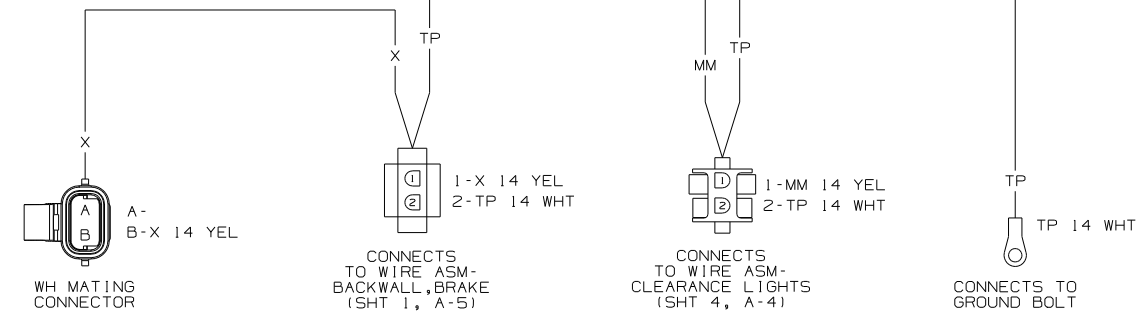

WIRING DIAGRAM-CLEARANCE LIGHTS  
 (WIRE ASM 132085-02 REV-E)

- 5 SEE WIRING DIAGRAM-AUTO FOR ADDITIONAL INFORMATION.
- 4 SEE MANUFACTURERS DIAGRAM FOR ADDITIONAL INFORMATION.
- 3 GROUNDS ARE SHOWN AS A SINGLE LINE FOR EASE IN TRACING. EACH GROUND CIRCUIT IS SEPERATE IN THE HARNESS.
- 2 NOT A SPLICE POINT. INDICATES ENTRY INTO WIRING HARNESS.
1. SPLICES ARE THEORETICAL AND MAY DIFFER IN THE HARNESS.

NOTES:

FIRST USED	05 D-SER
TITLE	DO NOT SCALE DRAWING
	WIRING DIAGRAM-AUTO LAMPS
SHEET 4	PART NO 148572