

2003 RIALTA SEALANTS CALLOUT SHEET

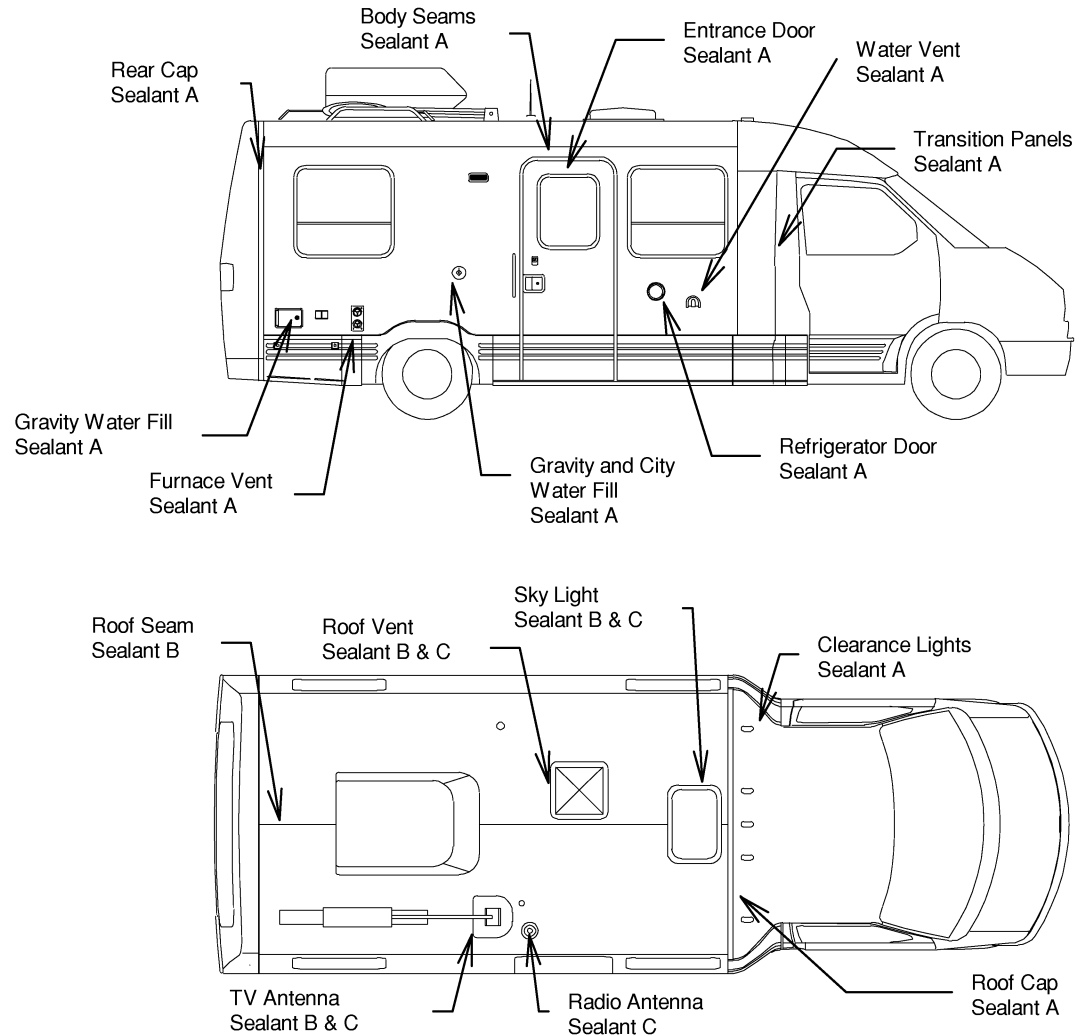

Sealants may be purchased from your Winnebago or Itasca Dealer

This is only a graphic representation for sealants and does not represent actual component position

Sealant	Winnebago Part #
A	072889-22-000
B	131264-03-01A
C	131264-01-02A

Revision A

NOTE: All painted aluminum skin surfaces that have silicone applied too, must be wiped with lacquer thinner. (45704-02) Follow procedure outlined below:

- a. Wipe area for silicone application with lacquer thinner. (45704-02) Application should wet the surface for at least 5 seconds.
- b. After the surface is wet wipe excess from the surface with a dry towel
- c. Allow remaining thinner to flash off, then apply the silicone within 5 minutes of thinner application