



**DANGER**

**Danger of electrical shock, burns or death.** Always remove all power sources before attempting any repair, service or diagnostic work. Power can be present from shore power, generator, inverter or battery. All power sources must be disabled and secured before performing any service.



**CAUTION**

If you lack the skills, tools or equipment to perform diagnostic or repair work leave such work to an authorized Winnebago Industries dealer or other qualified shop.

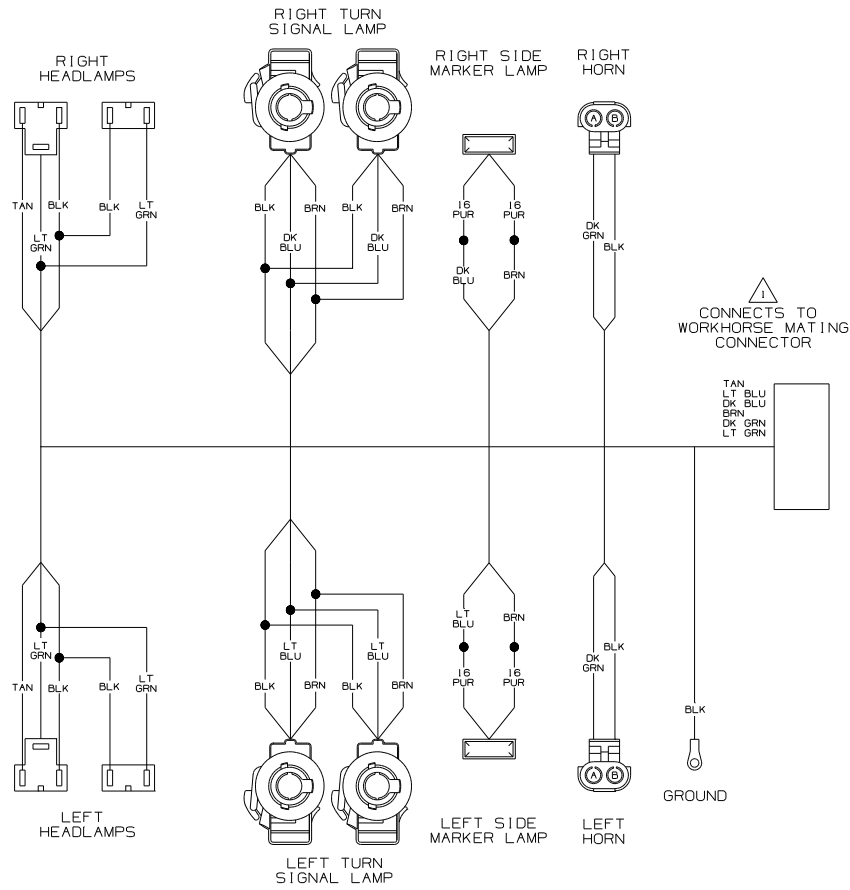

WIRING DIAGRAM-HEADLAMP  
 (WORKHORSE CHASSIS)  
 (WIRE ASM-103784-30)  
 (WINNEBAGO)

1. SEE MANUFACTURERS DIAGRAM FOR ADDITIONAL INFORMATION.  
 NOTES:

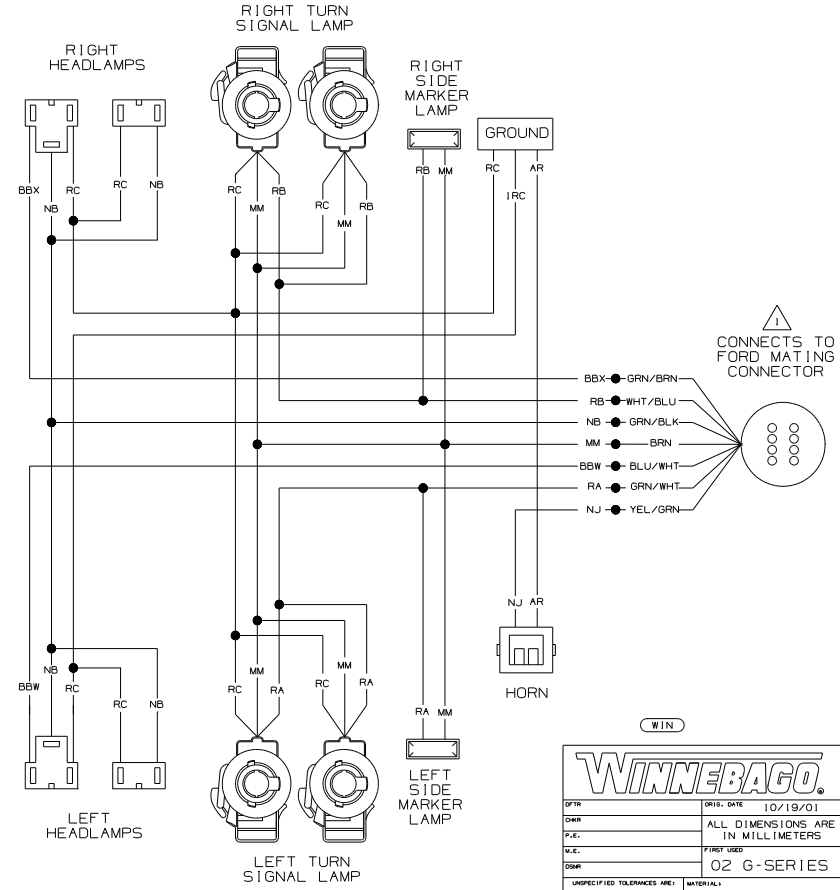

WIRING DIAGRAM-HEADLAMP  
 (FORD CHASSIS)  
 (WIRE ASM-103784-26)  
 (WINNEBAGO)

WINNEBAGO

ORIG. DATE 10/19/01

ALL DIMENSIONS ARE IN MILLIMETERS

02 G-SERIES

UNSPECIFIED TOLERANCES ARE:	MATERIAL:
THIRD ANGLE PROJECTION	

DO NOT SCALE DRAWING

WIRING DIAGRAM-AUTO LAMPS

SHEET 1 of 4 PART NO 138202

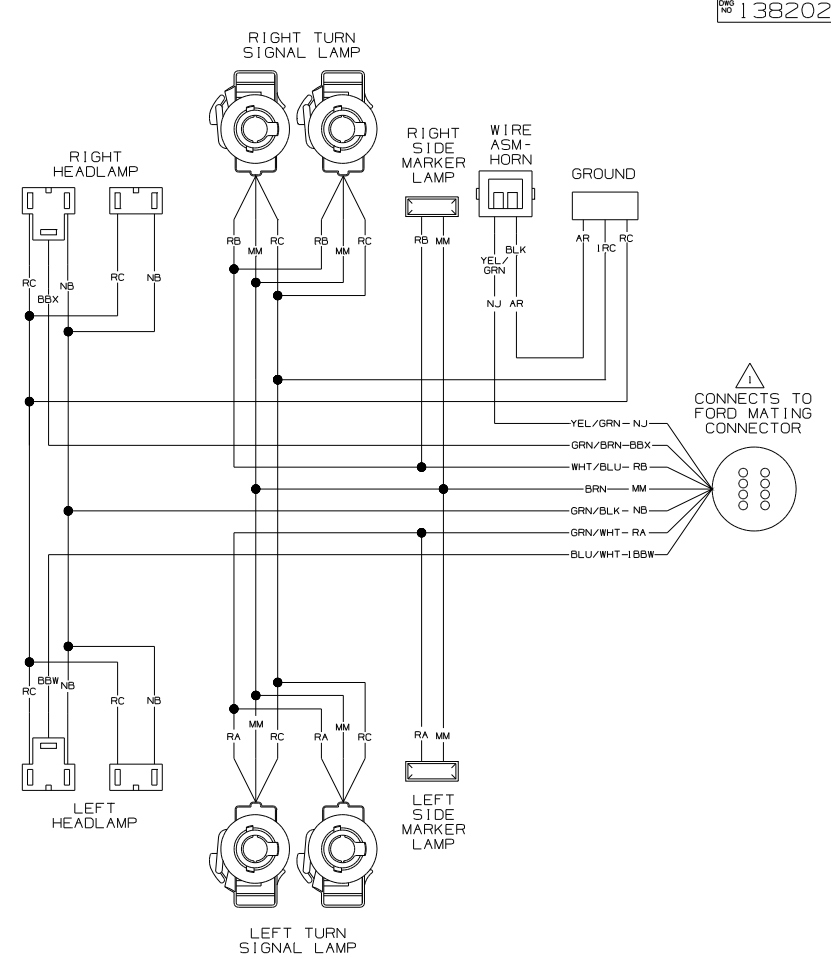
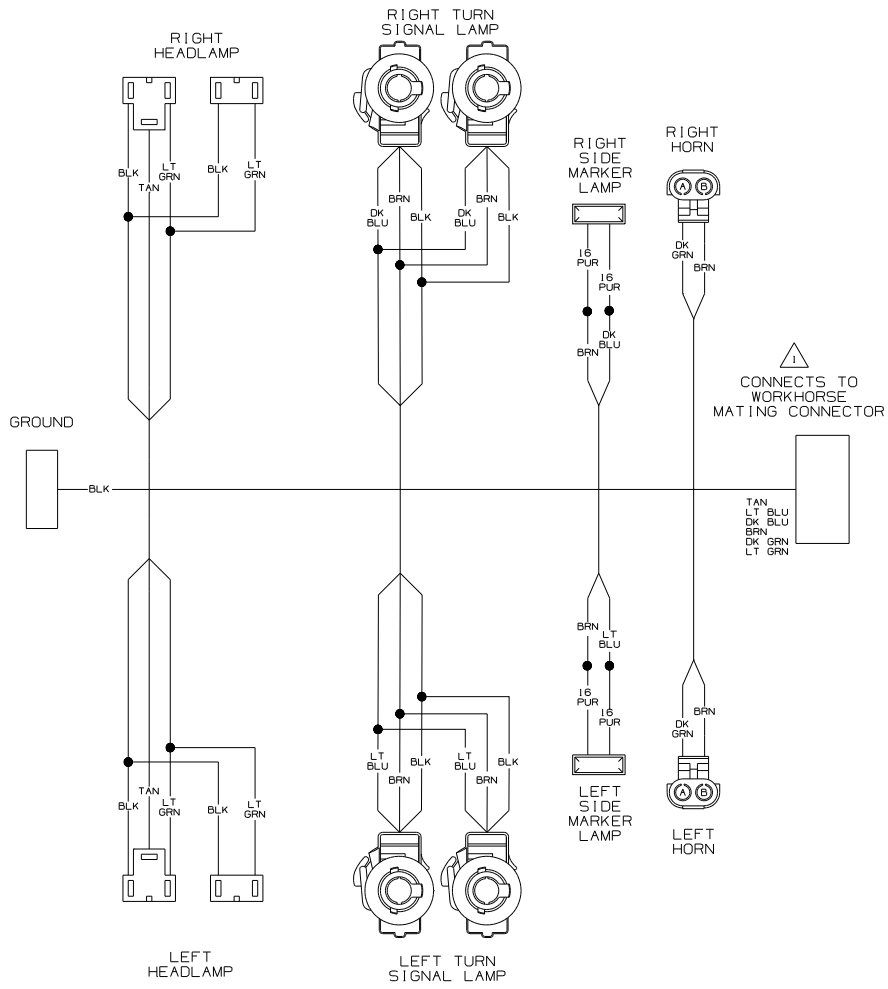

1. SEE MANUFACTURERS DIAGRAM FOR ADDITIONAL INFORMATION.  
NOTES:

(ITA)	
FIRST USED <b>02 G-SERIES</b>	
DO NOT SCALE DRAWING	
TITLE: <b>WIRING DIAGRAM-AUTO LAMPS</b>	
SHEET 2	PART NO <b>138202</b>

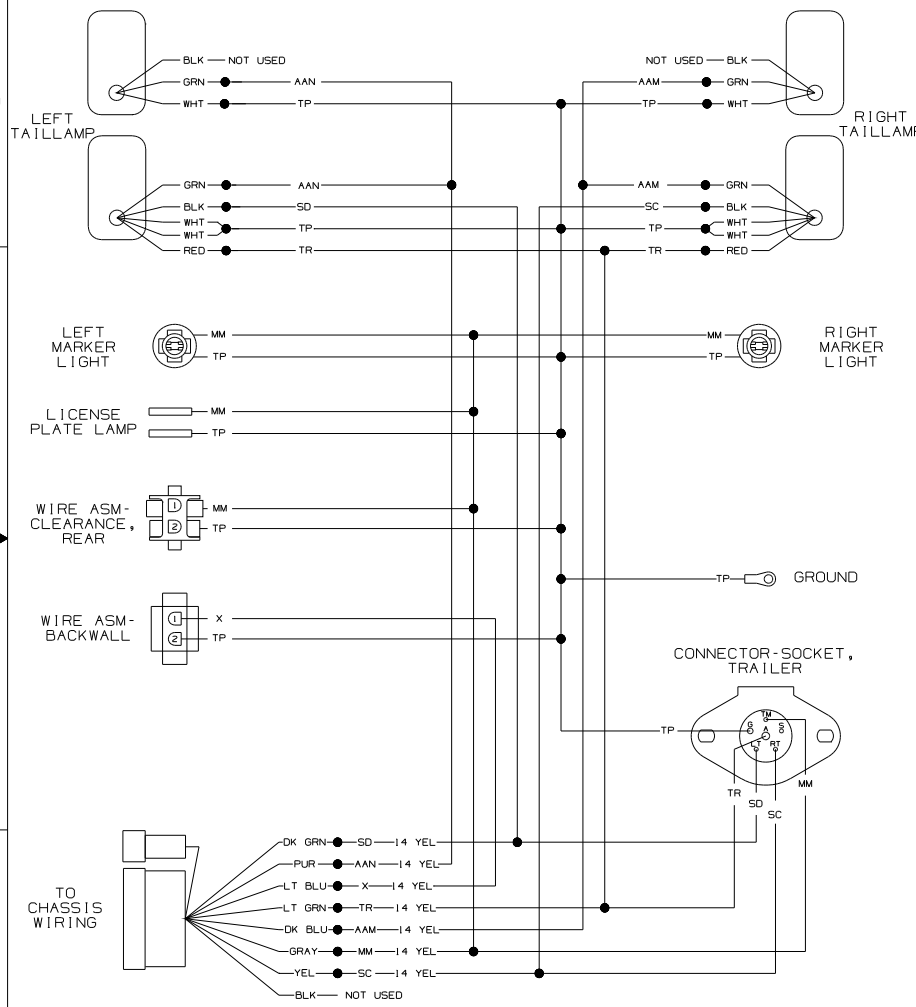

WIRING DIAGRAM-TAILLAMPS, WH  
(WORKHORSE CHASSIS)  
(WIRE ASM-132730-03)

NOTES:  
1 SEE MANUFACTURER'S DIAGRAM FOR ADDITIONAL INFORMATION.

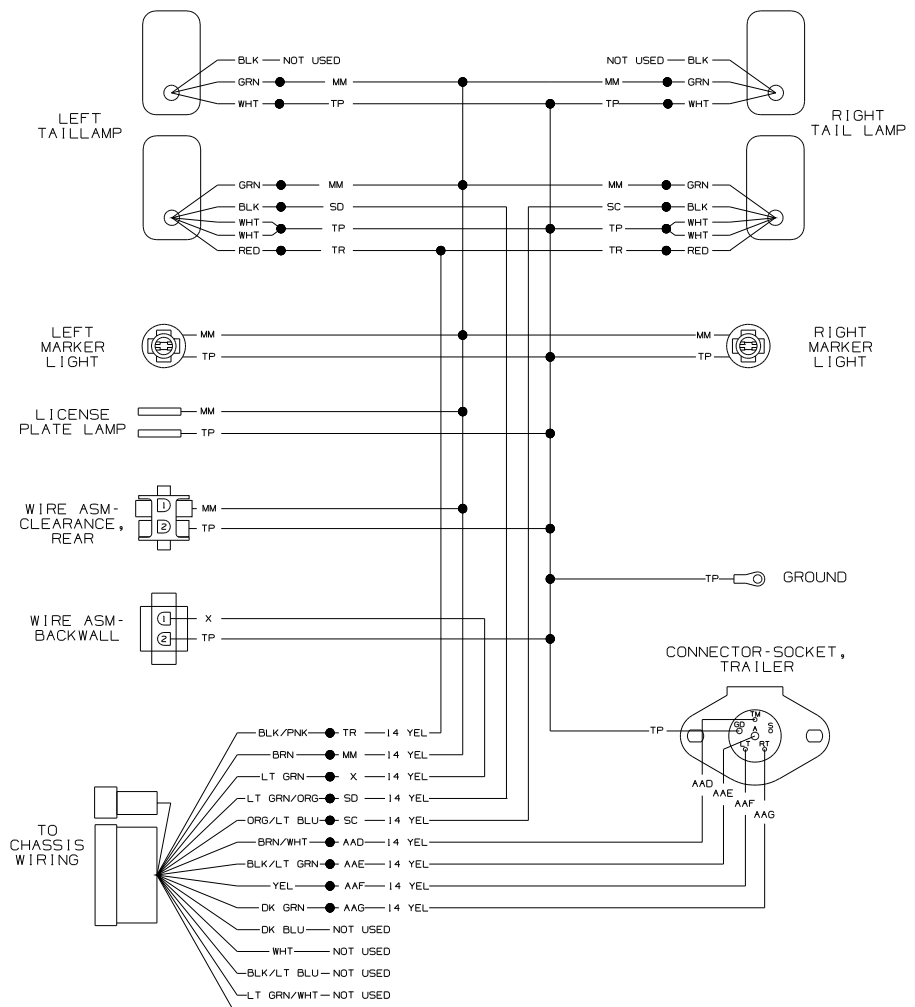

WIRING DIAGRAM-TAIL LAMPS, FD  
(FORD CHASSIS)  
(WIRE ASM 132730-01)

FIRST USED	02 G-SERIES
DO NOT SCALE DRAWING	
TITLE: WIRING DIAGRAM-AUTO LAMPS	
SHEET 3	PART NO 138202

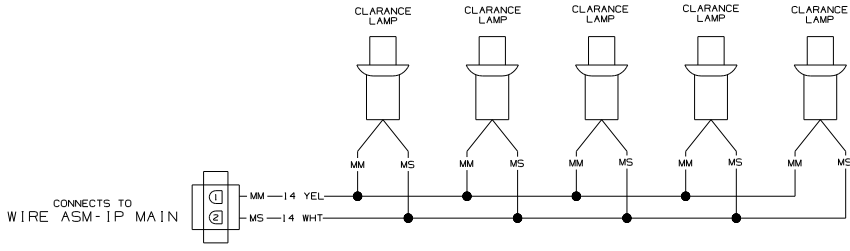

WIRING DIAGRAM-CLEARANCE LAMPS  
(WIRE ASM 126499-01)

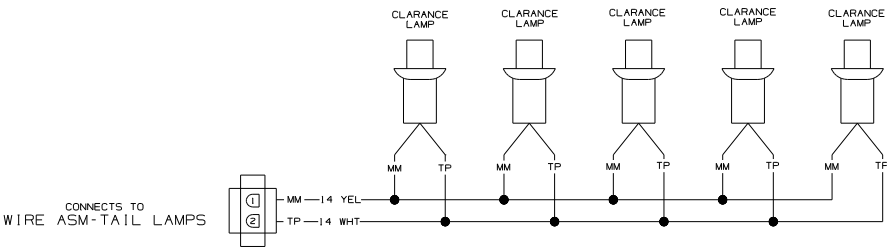

WIRING DIAGRAM-CLEARANCE LAMPS  
(WIRE ASM 132729-01)

1. SEE MANUFACTURERS DIAGRAM FOR ADDITIONAL INFORMATION.

NOTES:  
NOTES:

FIRST USED		02 G-SERIES	
DO NOT SCALE DRAWING			
TITLE: WIRING DIAGRAM-AUTO LAMPS			
SHEET 4	PART NO	138202	